

RECORD IMPRESSION-57
AUTOMATIC SPEED GATE

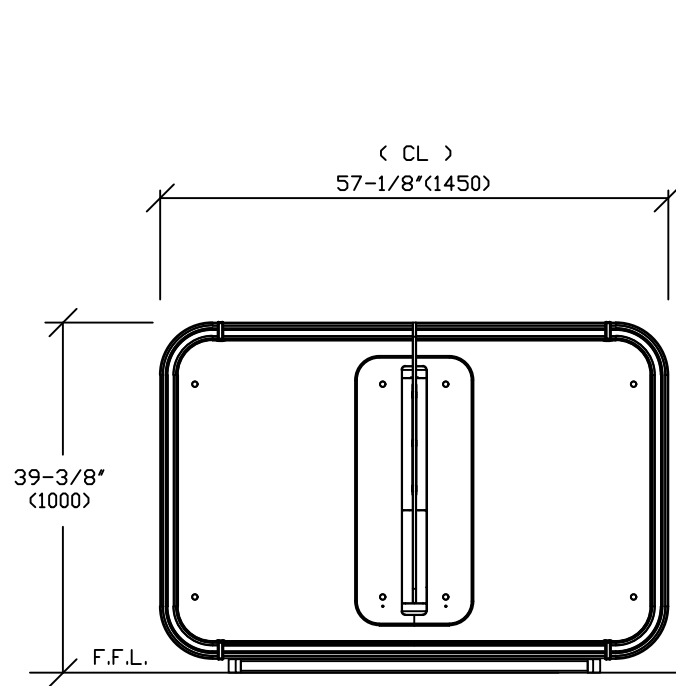

SIDE VIEW

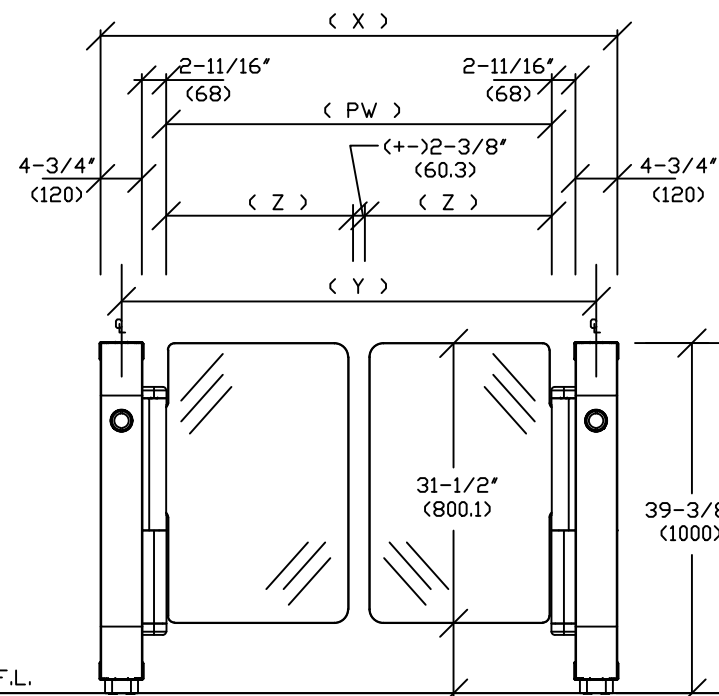

FRONT VIEW
LOW GLASS

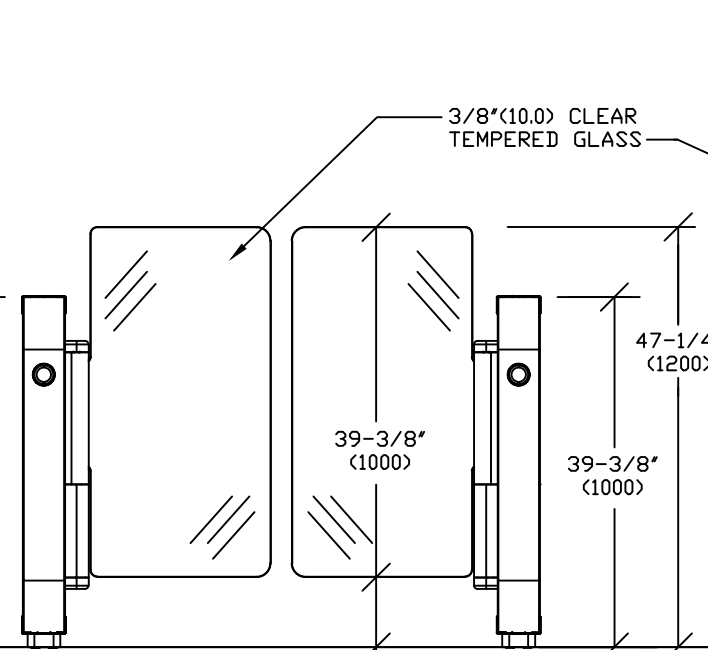

FRONT VIEW
MID GLASS

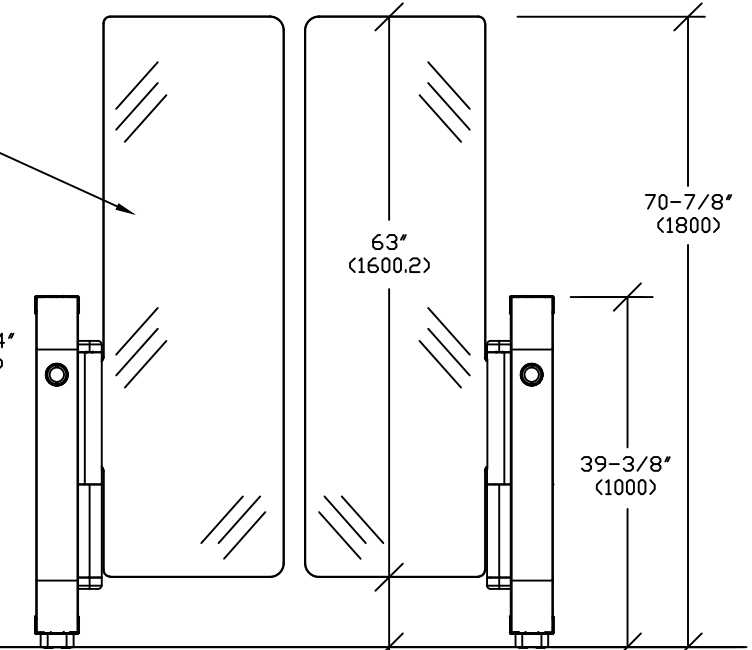

FRONT VIEW
HIGH GLASS

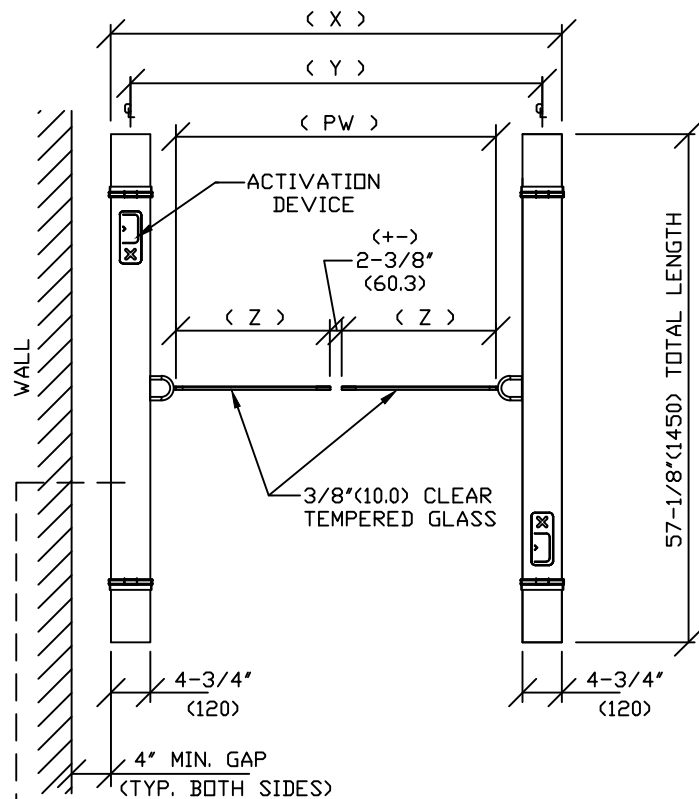

PLAN VIEW

110-240 VAC
ELECTRICAL -BY OTHERS

NOTE: CUSTOM UNIT WIDTH & CLEAR OPENING,
CONSULT FACTORY.

CABINET LENGTH (CL)	UNIT WIDTH (X)	CENTER (Y)	CLEAR OPENING (PW)	GLASS WINGS (Z)
57-1/8" (1450)	38-7/16" (976)	33-11/16" (856)	23-5/8" (600)	10-5/8" (269.8)
	42-13/16" (1087)	38-1/16" (967)	28" (711)	12-13/16" (325)
	50-13/16" (1290)	46-1/16" (1170)	36" (914)	16-3/16" (411.1)
	58-1/8" (1476)	53-3/8" (1356)	43-5/16" (1100)	20-1/2" (4520.7)

DIMENSIONS ARE IN INCHES [mm]

THE RECORD IMPRESSION SPEEDGATE IS INTENDED EXCLUSIVELY FOR PEDESTRIAN PASSAGE AND INDOOR USE ONLY.

NOTES

- CABINET TYPES: OPEN / CENTER GLASS / BOXED.
- STANDARD EQUIPMENT: CABINET, CLEAR GLASS LEAFS, SAFETY SENSORS, DRIVE UNIT, LED LIGHT BAND AND LED PICTOGRAM.
- ACTIVATION: CARD READER, BIOMETRIC READER OR ANY OTHER ACCESS CONTROL TYPE (ACTIVATION BY OTHERS).
- POWER INPUT: 110vac 240vac0-50/60 Hz.
- FINISHES: RAL POWDER COATINGS, AXALTA POWDER COATINGS.
- ACCESSORIES:
 - RAISED FLOOR MOUNTING PLATFORM.
 - MANUAL PUSH BUTTON CONTROLLER.
- GLASS HEIGHTS:
AVAILABLE IN 31-1/2"(800.1), 39-3/8"(1000.1) & 63"(1600.2)

DWG NO: IMPRESS-57-1G
 DRN BY DDD DATE 07/19/2024 CHK BY DATE REV. G DATE 01/28/25



JOB NAME: _____